



For companies of the tool-making and mold-making sector, the plastics- and casting-industries

TOOL4SEARCH

**Software solution for
calculation and design**
**Classified and geometric
similarity search**



For companies of the tool-making and mold-making sector, the plastics- and casting-industries

TOOL4SEARCH

Non-sector-specific

Organisationsbüro Bübel

only for example



For companies of the tool-making and mold-making sector, the plastics- and casting-industries

TOOL4SEARCH

TOOL4SEARCH-Basis (classified similarity search)



TOOL4SEARCH-Extension (geometric similarity search)



IDEA:

Software solution for calculation and design



For companies of the tool-making and mold-making sector, the plastics- and casting-industries

TOOL4SEARCH-Basis

Calculation based on gut feeling / Memory / Excel tables



Calculation software



IDEA:

Classified similarity search

For companies of the tool-making and mold-making sector, the plastics- and casting-industries

Classified similarity search

Find comparable molds by using relevant keywords

Inquiry:

Injection mold
4-fold
3 Sliders
Article group - plug connectors

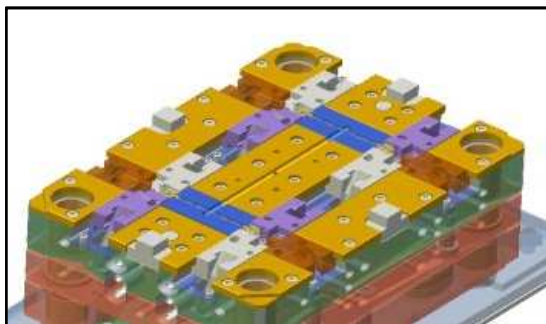
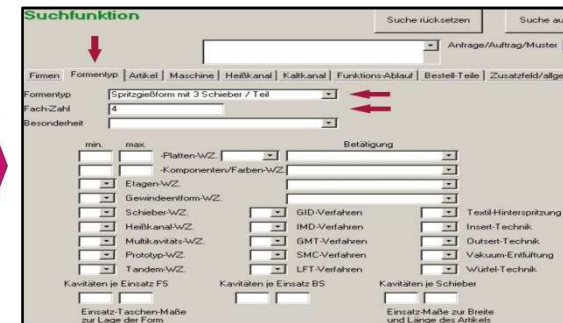
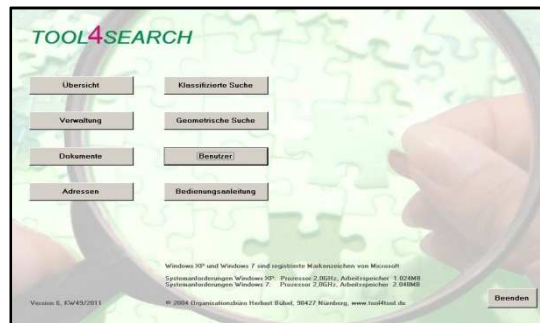

| Art-Nr. | Datum | Art-Nr. | Art-Nr. | Art-Nr. | Art-Nr. | Art-Nr. | Art-Nr. | Art-Nr. | Art-Nr. |
|---------|------------|---------|---------|---------|---------|---------|---------|---------|---------|
| 1111200 | 11.11.2000 | 1111200 | 1111200 | 1111200 | 1111200 | 1111200 | 1111200 | 1111200 | 1111200 |
| 1111200 | 11.11.2000 | 1111200 | 1111200 | 1111200 | 1111200 | 1111200 | 1111200 | 1111200 | 1111200 |
| 1111200 | 11.11.2000 | 1111200 | 1111200 | 1111200 | 1111200 | 1111200 | 1111200 | 1111200 | 1111200 |
| 1111200 | 11.11.2000 | 1111200 | 1111200 | 1111200 | 1111200 | 1111200 | 1111200 | 1111200 | 1111200 |
| 1111200 | 11.11.2000 | 1111200 | 1111200 | 1111200 | 1111200 | 1111200 | 1111200 | 1111200 | 1111200 |

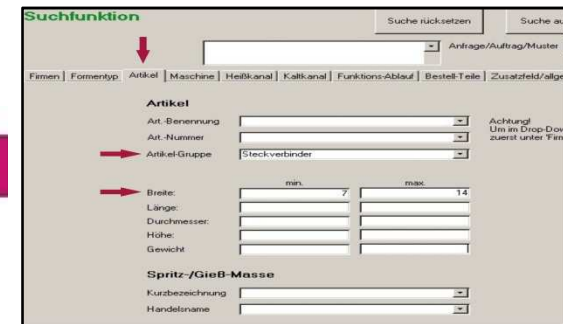



For companies of the tool-making and mold-making sector, the plastics- and casting-industries

TOOL4SEARCH-Extension

3D Parts data - Basis for calculation and design



3D Parts data - Recognition (fingerprint)



IDEA:

Geometric similarity search



TOOL4SEARCH-Partnership

Geometric similarity search



Partner software



IDEA:

CADENAS - PARTsolutions/GeoSearch



For companies of the tool-making and mold-making sector, the plastics- and casting-industries

Geometric similarity search

Find comparable parts by using fingerprint identification

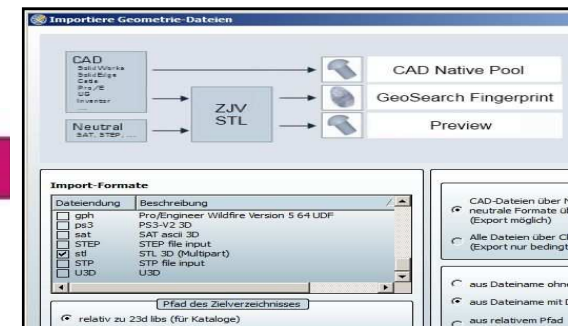
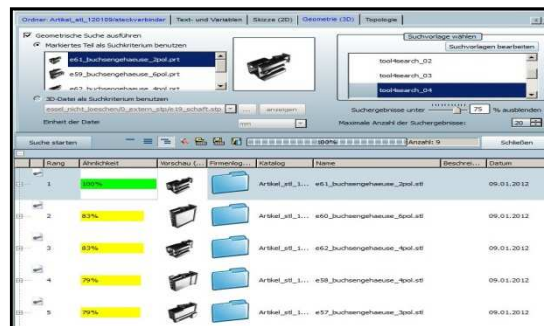
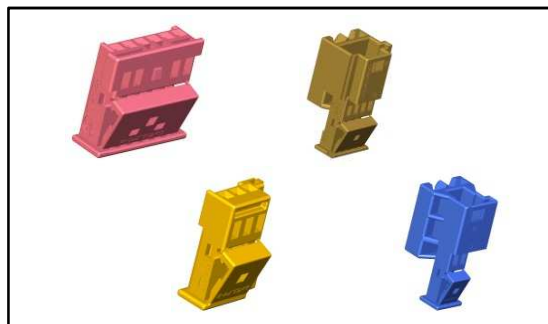
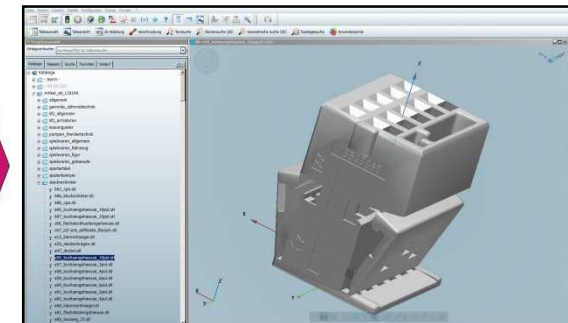
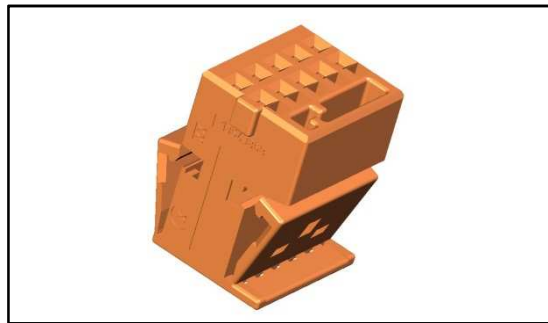



For companies of the tool-making and mold-making sector, the plastics- and casting-industries

TOOL4SEARCH-Field of application:

Part calculation/design (development)

Mold calculation/design

Mold manufacturing/maintenance

AIM:

Standardization – edge through utilization



For companies of the tool-making and mold-making sector, the plastics- and casting-industries

Part design (development)

Standardization - edge through utilization

Fast recover of existing parts

Reduce part variety up to 50%

Avoid the creation of duplicates

Increase reusability

Shorten new developments



For companies of the tool-making and mold-making sector, the plastics- and casting-industries

Mold design

Standardization – edge through utilization

Fast recover of existing molds

Reduce mold variety up to 30%

Rationalize own components

Increase reusability

Shorten design times



For companies of the tool-making and mold-making sector, the plastics- and casting-industries

Mold manufacturing/maintenance

Standardization – edge through utilization

Fast recover of existing spare parts

Reduce spare part variety up to 50%

Downsize spare part depots

Minimize manufacturing costs



**Konstruktionsbüro
Herbert Bübel**

**Organisationsbüro
Herbert Bübel**



For companies of the tool-making and mold-making sector, the plastics- and casting-industries

End of the presentation

Thank you for
your attention